

Ezekiel: Retribution & Restoration

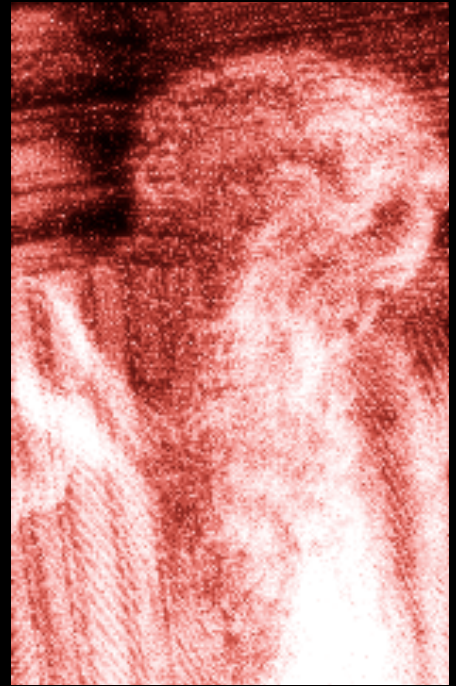

Welcome to Ezekiel: Retribution & Restoration with Dr. Jimmy DeYoung

It is our sincere prayer that this video and workbook will help guide you through a profitable study of the prophetic Word of God.

School of Prophets Institute

PO Box 2510
Chattanooga, TN 37409

(423) 825-6247

www.schoolofprophets.org

How to use this Workbook

This workbook was designed to be used with the Ezekiel: Retribution & Restoration CD Series, either as a part of a small group Bible study, such as a Sunday School class or family devotions, or for personal Bible study. You are free to use the workbook as you see fit, but most people seem to get the most out of it when they listen to the audio study CDs with their Bibles and their workbooks open, so they can follow along in God's Word and take notes in the workbook.

There are 7 CDs and 7 lessons in the Workbook. If you are using this in a weekly bible study, you can do one CD a week for 7 weeks.

How this Workbook is set up

The workbook is divided into 7 lessons - each matching a CD in the Ezekiel: Retribution & Restoration audio series. Within each chapter you will find a *Lesson Overview*, a *Follow Along Outline* with fill-in the blanks, and a *Think About This* review of key thoughts for the lesson and gives thought provoking questions for you to answer.

If you have any questions

Please feel free to contact us at the School of Prophets Institute:

School of Prophets Institute

PO Box 2510

Chattanooga, TN 37409

(423) 825-6247

www.schoolofprophets.org

Overview of Ezekiel

I. Ezekiel: A Foundation of Biblical Prophecy

- Biography of Ezekiel
- Message of Retribution
- Message of Restoration

II. A Unique Man & Ministry

- Ezekiel's Peculiar Attributes
- The Four Living Creatures
- How to See the Glory of the Lord

III. The Fall of Lucifer & his Angels

- The Prince of Tyre
- Lucifer's Fall
- UFOs

IV. Dry Bones & Two Sticks

- The regathering
- The restoration

V. Islam & the Alignment of Nations

- The alignment of the nations
- A look at the Islamic world

VI. Esau & the Palestinians

- Describing the Jacob/Esau struggle
- The significance of 70 A.D.

VII. Temples: Past, Present, & Prophetic

- Temples Past
- Temple Present
- Temples Prophetic

Lesson One



Ezekiel: A Foundation of Biblical Prophecy

Ezekiel's Message lays the groundwork for Biblical Prophecy

Ezekiel's Message contains the record of God's prophetic timeline for the Jewish people. An understanding of this timeline is essential when studying the rest of God's prophetic Word.

Overview of Lesson One

I. An Introduction to Ezekiel

- *The Man*
- *His Message*

II. A Message of Retribution Chapters 1 - 32

- *To Israel - Chapters 1 - 24*
- *To Israel's Neighbors - Chapters 25 - 32*

III. A Message of Restoration - Chapters 33 - 48

- *Of the Jewish People*
- *Of the Jewish Practices*

Follow Along Outline

A Brief Bio of Ezekiel the Man

- ▶ His name means God is _____.
- ▶ His education was for ___ years at the rabbinical seminary (_____ school).
- ▶ His textbook was the book of _____.
- ▶ His vocation was the _____.
- ▶ His call to be a _____ came from God while he was in exile in Babylon.
- ▶ He was a priest/prophet called to minister to the exiles. The Lord called him, son of _____ . - *Ezekiel 2*
- ▶ He was the first _____ preacher that there ever was in history.

A Brief Look at Bible Prophecy in General

- ▶ _____% of the entire Bible is prophecy. This means one out of every three pages in the Bible is prophecy.

A look at history's timeline of 7,000 years – a roadmap through eschatology

- ▶ _____ years from Genesis 1 creation in six twenty-four hour days by Jesus Christ (Colossians 1:16) to His first coming to live, die, be buried, resurrected and ascended back to heaven.
- ▶ At least 2,000 years from that point to the _____ of the Church, the next main event on God's calendar of events. - *I Thessalonians 4:13-18, John 14:1-3*
- ▶ _____ years of the reign of Christ in His Millennial Kingdom followed by the Great White Throne Judgment, and Eternity Future (a New Heaven, a New Earth and a New Jerusalem) begins.

A _____ year period of time is talked about in Revelation 4:2-19:10, "a terrible time of tribulation." The word _____ is used 25 times in the book of Revelation, __ times before 4:1 and __ times after 19:11 and __ times in those 16 chapters describing the Tribulation period.

A Trio of Triplets

1. Three future events

- ▶ The _____ of the Church - *I Thessalonians 4:13-18*

- ▶ The _____ (or Return) of Jesus Christ - *Revelation 19:11*

- ▶ The _____ against unbelievers at the Great White Throne Judgment - *Revelation 20:11-15*

2. Three members of the human family

- ▶ _____ only for the first 2,000 years. - *Genesis 1-11*
 - _____ was a great preacher who was a Gentile believer. - *Genesis 4*
 - _____ was a great preacher who was a Gentile believer. - *Jude*
 - _____ was a great preacher who was a Gentile believer. - *Genesis 6, 7*
- ▶ Gentiles and _____ the second 2,000 years. - *Genesis 12 – Acts 1*
 - Abram is called the _____ - *Genesis 14:13*
 - Jacob, his grandson, was the first one to be referred to as _____. - *Genesis 32*
 - Judah, his great grandson, was the first one to be called a _____. - *II Kings 16*
- ▶ Gentiles, Jews and _____, the third 2,000 years. - *Acts 2 – Revelation 22*
 - There are no _____ in Matthew, Mark, Luke, or John.
 - Believers were first called _____ at Antioch. - *Acts 11:26*

3. Three books

- ▶ The book of _____ lays out the timeline for the Gentiles. Daniel and the three Hebrew children are taken into Babylonian captivity 605 B.C. This was the beginning of the times of the Gentiles, a time when a Gentile has control over Jewish people and the city of Jerusalem.
- ▶ The book of _____ is a timeline for the Christians. It starts with the Resurrection and takes us into Eternity Future. - *Revelation 1:18*
- ▶ The book of _____ is the timeline of the Jews. Ezekiel, in preparing for the priesthood, studied the book of Leviticus for 28 years. Chapters 1-7 describe a system of sacrifices. Chapters 8-11 give standards for the priest. Chapters 12-27 give a system of worship in a tabernacle or temple.

THE BOOK OF EZEKIEL

- ▶ It is one of four books in the Bible that is _____ which means to foretell the future, the others being Daniel, Zechariah and Revelation. This type of literature uses a _____ to communicate an absolute truth.

Ezekiel's status and location

- ▶ He had just qualified as a priest at age 30 and was in Mesopotamia, present-day _____. Where was Noah living in his later years? Mesopotamia. His great grandson, Nimrod, built a great city called _____.

Ezekiel, a major player in all of world history, pre-writes history happening today from the location where our world is focused today, _____.

An Outline of the Book of Ezekiel

1. A message of _____ - *Ezekiel 1-32*

- ▶ To Israel - *Ezekiel 1-24*
- ▶ To Israel's neighbors - *Ezekiel 25-32*

2. A message of _____ - *Ezekiel 33-48*

- ▶ Of the Jewish people - *Ezekiel 33-39*
- ▶ Of Jewish practices - *Ezekiel 40-48*

Conclusion

- ▶ The absence of the word church in Revelation 4:2 - 19:10 is one indication we will not be here during the seven year Tribulation period.
- ▶ Which member of the human family are you – Gentile, Jew or Christian?
- ▶ Are you ready for the next main event on God's calendar, the Rapture of the Church?

Think About This!

1. What are some key facts about Ezekiel the man?
2. What are the three main events remaining on God's prophetic timeline?
3. What are the three branches of the human family?
4. What are the 2 major messages of Ezekiel's prophecy?
5. Where was Ezekiel's ministry carried out?

Lesson Two

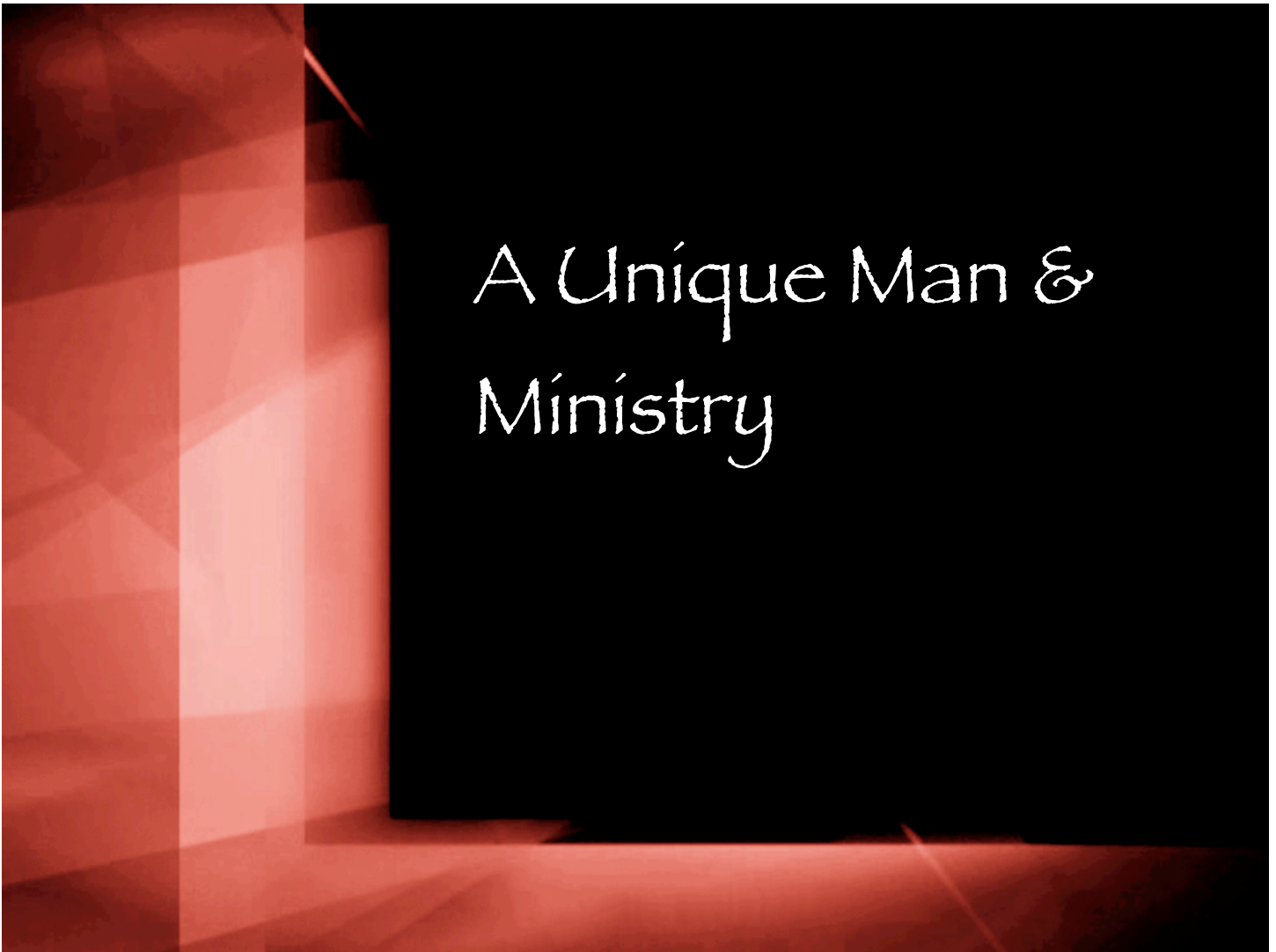

"Son of man, I have made thee a watchman unto the house of Israel: therefore hear the word at my mouth, and give them warning from me."

Look around and see the glory of the Lord. walk in obedience following Ezekiel's example in serving the Lord. be a watchman, hear from the Lord and warn people to be prepared for the Lord's appearing and return.

Overview of Lesson Two

I. Setting the Stage

- *A look at genealogies and events*
- *Identifying three Old Testament priests/prophets*

II. Diasporas & Aliyahs

III. Ezekiel's Peculiar Attributes

- *His name*
- *His message*
- *His calling*
- *His handicaps*
- *His diet*

IV. Ezekiel's consistency in obedience

V. The Four Living Creatures

VI. How to See the Glory of the Lord

Follow Along Outline

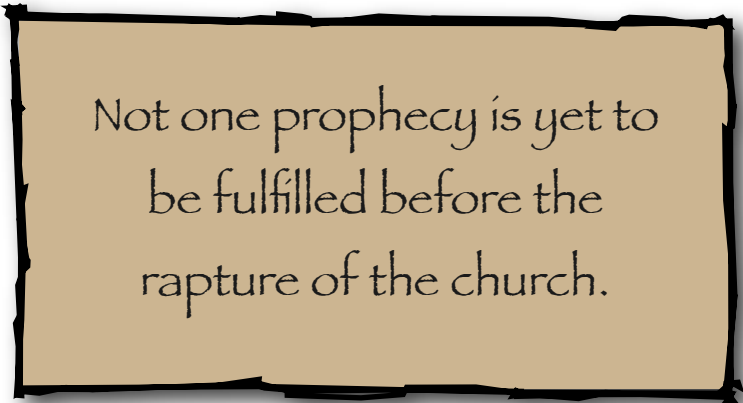

Not one prophecy is yet to
be fulfilled before the
rapture of the church.

A look at genealogies and events

- ▶ We see these two uniquely combined in Matthew 1:17 – from Abraham to David 14 generations, from David to the carrying away into Babylon 14 generations, and from the carrying away into Babylon to Christ 14 generations. The _____ was a very unique event.

Three Old Testament priest/prophets

- ▶ _____ was 30 years of age when he was taken into Babylonian captivity in 597 B.C. He had already qualified as a priest, but was never able to practice the priesthood.
- ▶ _____ was a priest who God called to be a prophet.
- ▶ _____ was a priest who God called to be a prophet and who returned to Jerusalem encouraging the people to rebuild the Temple.

Three Diasporas and Aliyahs

- ▶ In Genesis Jacob took his 70 family members into Egypt, dispersed from out of the land due to famine. 430 years later through the leadership of Moses and Joshua they are delivered (commemorated by the Feast of _____) and return two million strong.
- ▶ The dispersion of the Jews to _____ occurred in 605 B.C. with Daniel and the three Hebrew children, then Ezekiel in 597 B.C. and all the Jews in 586 B.C.. God raises up King Cyrus to allow the Jews to return to Jerusalem and build their Temple.
- ▶ The third departure of the people being taken out of the land occurred in 70 A.D. when the _____ was destroyed. The third return is in the process in our life time as described in Daniel 2:7. The Tribulation period is unfolding. God will bring to an end the times of the Gentiles.

The Times in which the Prophets Prophesied

- ▶ During the Babylonian captivity – _____ and _____
- ▶ After the return from the Babylonian captivity – _____, _____ and _____
- ▶ Prior to the Babylonian captivity – the other _____ prophets in the Old Testament

Distinguish between a true prophet and a false prophet

- ▶ The mark of a true prophet is ____% fulfillment of his prophecies.
- ▶ The mark of a false prophet is _____ (Matthew 24:4, 5, 11, 24) made manifest in signs, wonders and miracles.

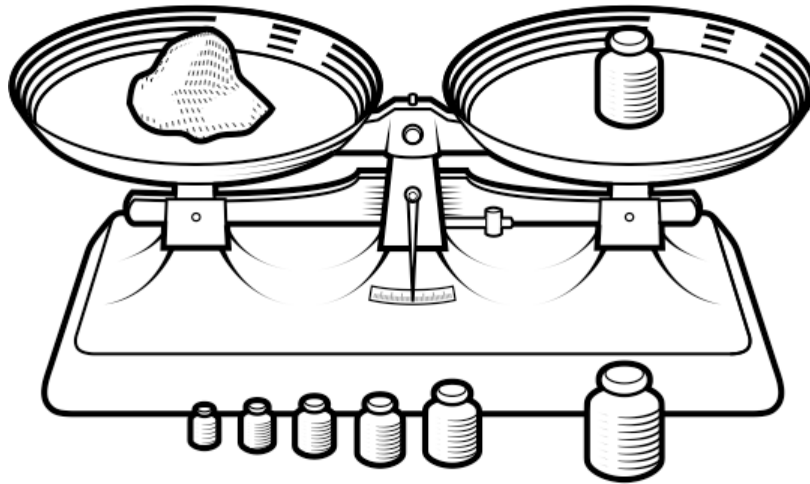

Ezekiel's Peculiar Attributes

- ▶ He is called "son of man" ____ times in this book. There is only one other person with that name, Jesus Christ, used only ____ times in the New Testament.
- ▶ His message was "Thus saith the Lord," used _____ times in the book of Ezekiel.
- ▶ His hearers (Israel) are described as hard headed, stiff necked, impudent, like scorpions, a _____ house.
- ▶ His calling was to be a _____, one who would stand on the city wall giving warning in defense against the enemy. We need to hear and talk what God's Word is saying about the end times in which we are living today warning the people.
- ▶ His handicap was that he was to lay in the street ____ days stricken unable to _____ - a silent street preacher.
- ▶ His daily diet was 8 ounces of meat, a quart of water and bread made over cow _____.

Three piles of hair shaved from Ezekiel's head and face - *Ezekiel 5:1, 2*

- ▶ The pile burned up = a third of Israel will die of pestilence and _____. - *Ezekiel 5:12*
- ▶ The pile stabbed by his dagger = a third of Israel will fall by the _____.
- ▶ The pile scattered by the winds = a third of Israel will be taken into _____.

What was Ezekiel's assignment in the valley of dry bones? - *Ezekiel 37*

- ▶ He was to go out and _____ (preach) to these dry bones.

When God said...

"Go to your people, a rebellious people and speak to them no matter what they say or look like."

Ezekiel said, "Yes sir!"

"Lay in the street 430 days on your left and right sides."

Ezekiel replied, "Yes sir!"

"Bake your bread over cow manure."

Ezekiel answered, "Yes sir!"

"Cut your hair off, stab it, burn it and then throw it in the air."

Ezekiel declared, "Yes sir!"

"I am going to take your beloved wife, but don't mourn. Get back to the task."

Ezekiel responded, "Yes sir!"

"Preach to a valley of dry bones,."

Ezekiel's reaction to God's command was always "Yes sir!"

The Four Living Creatures

- ▶ They are _____. - *Ezekiel 10*
- ▶ They all had four _____ and four _____. - *Ezekiel 1:6*
- ▶ They were standing in the form of a _____ forming a throne _____ to bring the glory of the Lord to the earth.
- ▶ The likeness of their faces were the face of a _____, a _____, an _____ and an _____. - *Ezekiel 1:10*
- ▶ It is believed that these display the different aspects of Jesus Christ as He came to earth.
 - Matthew describes Jesus as _____, King of Kings and Lord of Lords – the face of a lion, the _____ of the animal world.
 - Mark presents Jesus as a _____, the ox, the _____ animal.
 - Luke presents Jesus as a _____, the face of a _____.
 - John presents Jesus as _____, the face of an _____.
- ▶ The cherubim stand with two wings out and two wings covering their bodies, forming a perfect _____ with four _____ in all directions. - *Ezekiel 1:11*
- ▶ A _____ in the middle of a _____, that's how they move.
- ▶ The noise of their _____ was like the noise of many _____, as the voice of the _____.
- ▶ Ezekiel could say, "_____!" because he saw the _____ of the _____, a pre-incarnate appearance of Christ.

How to See the Glory of the Lord

- ▶ If we literally see the _____ of the _____, we will be immediately obedient as well. According to Psalm 19:1-6 we see it in God's _____. *"The heavens declare the _____ of _____; and the firmament sheweth his handiwork."* - Psalm 19:1
- ▶ In Genesis 1 He creates the sun, the moon and the stars also. In the end times there will be those who will deny the _____ of the Lord and His _____. II Peter 3:5 says they will be "*willfully ignorant*" (dumb on purpose).

Conclusion

- ▶ Look around, and see the glory of the Lord.
- ▶ Walk with the Lord today in obedience, and be a blessing.
- ▶ Be a watchman. Hear from the Lord. Warn the people.
- ▶ It is good to know the prophecies of Scripture about the Lord. It is better to love the Lord. Such love causes a sincere longing to see Him face-to-face.
- ▶ A crown of righteousness for all who love His appearing. - *II Timothy 4:7, 8*

Think About This!

1. Who were the three Old Testament prophets who were also priests?
2. What are the three time periods in which the prophets preached?
3. How can you distinguish between a true prophet and a false prophet?
4. How do the four faces of the living creatures relate to the four gospels?
5. What should our reaction be to God when He gives us a command?

Lesson Three

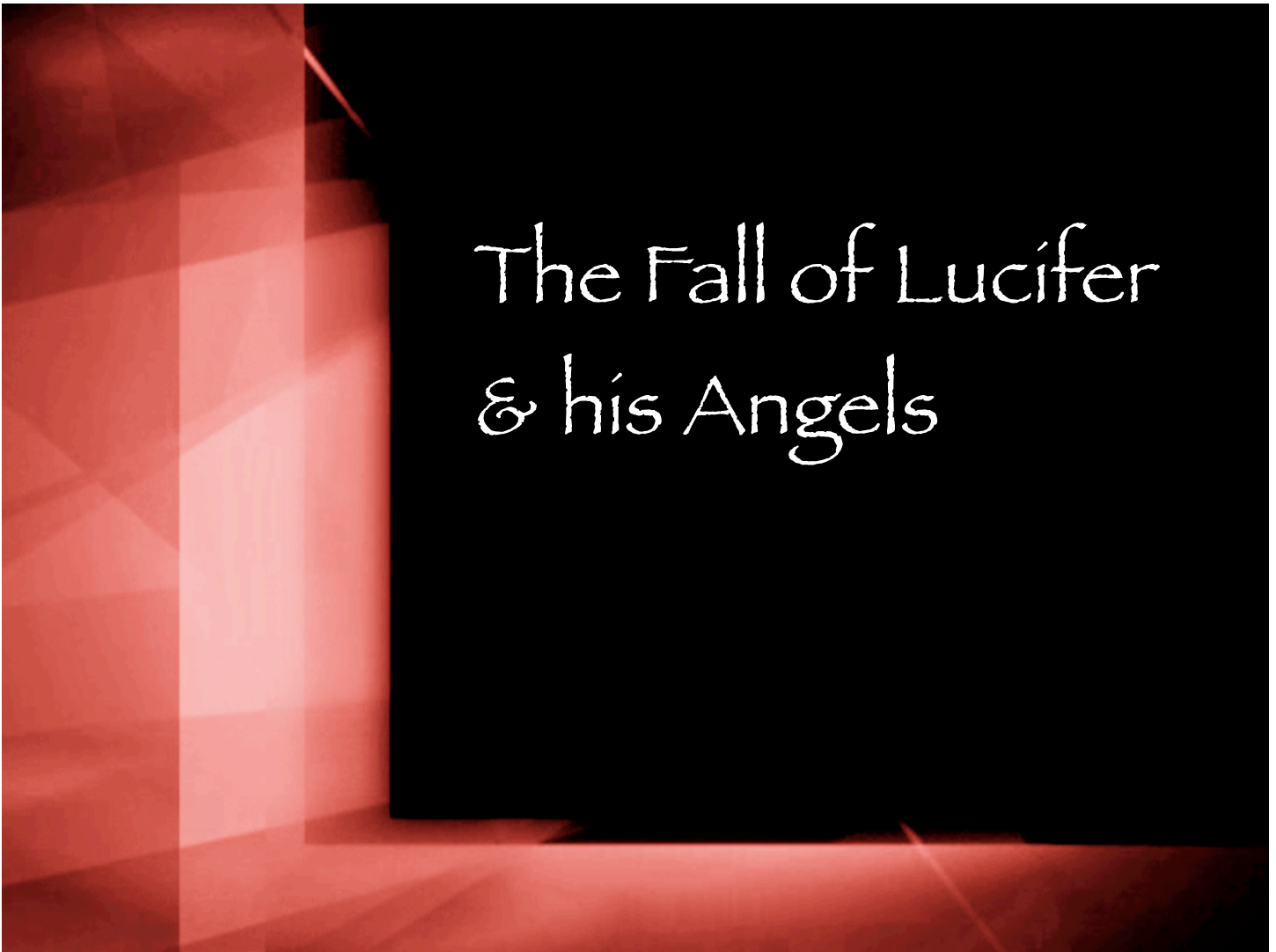

Our Enemy is real... And his time is short.

My decisions today will affect tomorrow. Therefore, I must stand against the schemes of Satan in the power of God's armor.

Overview of Lesson Three

I. Identifying the Prince of Tyre - *Ezekiel 28:1*

II. Lucifer's broad sphere of influence - *Ezekiel 28:13, 14*

III. Lucifer's Fall - *Isaiah 14:12-14*

- *When angels were created*
- *Identifying the three heavens*

IV. Dealing with Satan's schemes - *Ephesians 6:10-18*

V. Identifying and describing UFOs

Follow Along Outline

Identifying the Prince of Tyre

- ▶ In Ezekiel 28:1 it is talking about modern day _____. It was to southern _____ that Hezbollah, the Iranian Revolutionary Guard, came out of Iran in 1982. They were placed in southern _____ and responsible for the blowing up of the U.S. Marine Barracks killing over 280 U.S. military, and then for the 2006 thirty-four day cross-border law where, according to the perception of the Islamic-Arab world, Israel was defeated. It is talking about a judgment against Tyre, modern day Lebanon.

- ▶ Down in verses 13 and 14 it is talking about Lucifer.
 - He was in the _____ of _____. He was created, the anointed Cherub upon the Holy Mountain of God, according to Daniel 9:16, 20 the city of Jerusalem, synonymous with the _____ of _____.
 - The phrase, "the holy mountain of God," is used ___ times in the Old Testament, and has in its context the Temple Mount in the city of Jerusalem.
 - It is Mount _____ where Abraham offered Isaac (Genesis 22), where Solomon built that Temple (II Chronicles 3:1). It is the original site of the _____ of _____.
 - Lucifer was perfect in all his ways until _____ was found in him. Why did he fall? Because angels were created with a free will as is man.

How do human free will and angelic free will differ?

- ▶ We can change our minds as we exercise our free will. However, an angel has only _____ opportunity to exercise his free will, and at that point he is locked in for eternity. There is no _____ for an angel.

How did Lucifer fall?

- ▶ He exercised his free will against God in Isaiah 14:12-14 where he said,

I will ascend into heaven.

I will exalt my throne above the stars
of God.

I will sit also on the mount of the
congregation in the sides of the north.

I will ascend above the heights of the
clouds.

I will be like the Most High!

With this the battle of the ages begins!

The Creation of Angels

- ▶ In Job 38:4 God asks Job, "Where were you when I laid the _____ of the earth?"
- ▶ In Job 38:7 God says, "When the morning ____ sang together and all the ____ of God shouted for joy." The "morning stars" and the "sons of God" are phrases that describe angels. Whenever God _____ the earth, the angels shouted for joy!
- ▶ Between Genesis 1:1a and 1b God brought angels into existence. They were there before the earth was created, and they were all _____ angels.
- ▶ This is verified in Genesis 1:31 where God saw _____ He created, and it was very good (abundantly excellent). Evil angels were not in existence before Genesis 1:1.

The Fall of some of the Angels

- ▶ They did not fall in the six days of _____.
- ▶ A time frame would be between the _____ day of creation and Genesis 3:1, the time when God _____ with Adam and Eve.
- ▶ Genesis 3:1 speaks of a serpent. Who is the serpent? In Revelation 12:9 he is called the _____ and Satan. He appears sometime between Genesis 1:31 and 3:1.
- ▶ Lucifer was the most prominent, above all creation, above the _____ of God, in the Garden of Eden.

What turned Lucifer against God?

- ▶ Because God gave man _____ over every living thing that moved on the earth. - *Genesis 1:28*
- ▶ Lucifer did not like that because he was in charge of creation, and now _____ was in charge.
- ▶ So Lucifer becomes Satan sometime after the _____ day of creation early on in the existence of humankind.

The Three Heavens

- ▶ The first heaven is where the _____ and _____ are.
- ▶ The second heaven is where the _____ and _____ are.
- ▶ The third heaven is where _____ is and where the _____ were.

A third of the angels rebelled with Lucifer and were _____ of the third heaven.

- ▶ Lucifer, Satan, is the only _____ angel with access to the third heaven. What does he do there? According to Revelation 12:10 he _____ the brethren day and night before the throne of God.

What about UFOs? What do they look like? Why are they seen?

- ▶ Revelation 9 says _____ (not normal) creatures are going to come out of heaven and attack the earth.
- ▶ They have the face of a man, the hair of a woman, the teeth of a _____, the breastplate of a horse running to battle, and a tail like a _____ to kill and sting.
- ▶ They are _____ angels taking on the form of whatever we have seen out there. Satan has a plan to explain away the Rapture. "The _____ took them!"

Other appearances of Satan

- ▶ He takes of the form of an angel of _____ in II Corinthians 11 and his ministers the ministers of _____.
- ▶ Daniel 10 speaks of the "Prince of Persia", the "Prince of Greece". "Prince" is another title for the _____ angels. They come and take control of human bodies, a la Adolf Hitler killing six million Jews, Yassar Arafat who classified a 13 year old Palestinian female suicide bomber as a heroine. The most prominent one will be the _____.

Conclusion

- ▶ The Antichrist cannot appear until we depart from one place and go to another – the rapture of the church. We are at that time in history.

- ▶ We are going to make decisions today that affect tomorrow. The way we can understand what is going to happen tomorrow is to develop a world view based upon God's Word and the prophetic scenario laid out in it.

Think About This!

1. Who was the Prince of Tyre in Ezekiel 28? (There may be more than one answer.)
2. How and when did Lucifer fall and become Satan?
3. What are the three heavens?
4. When were angels created?
5. What are the "UFOs" that Dr. DeYoung talks about?

Lesson Four



Dry Bones & Two Sticks

Nothing is over until God says its over

The scene was bleak, to put it mildly. The once beautiful meadow was covered with the long-dead remains of a multitude of people. Not only were the bones sun-bleached dry, but they were scattered around. The leg bone of one man next to the skull of another next to the rib of another. One cannot be sure of the beginning of this story, but it is obvious that the end was massive death. But God...

But God had other plans. "Preach to these bones, Ezekiel." And he did. In a short while, the proud army, long since dead, stood, alive and well, bones, flesh, and even breath. Where man puts a period, God can put a comma. When things seem not just bleak, but final - keep your faith in God.

Overview of Lesson Four

- I. **God's message of retribution - *Ezekiel 1-32***
- II. **God's message of restoration - *Ezekiel 33-48***
- III. **The valley of dry bones - *Ezekiel 37***
- IV. **The regathering – 1897 - 1948**
- V. **The restoration – 1948 - Present**
 - *The three dispersions*
 - *The land*
 - *The people*
 - *The language*
- VI. **The case for all twelve tribes being in the land**
- VII. **When the Jewish people become the children of God and God becomes their God**

Follow Along Outline

The valley of dry bones

In Ezekiel 37 God takes Ezekiel out to a valley of dry bones. He asks Ezekiel, Can these bones _____ again? He tells the prophet he must _____ to these bones.

The result of Ezekiel's preaching - *Ezekiel 37:7 - 10*

- ▶ Those _____ came together.
- ▶ _____ came upon them.
- ▶ Out of the sky comes a covering of _____.
- ▶ The wind caused these flesh covered bones to _____ and to _____ up like a mighty army.

This is a three part prophecy using _____ literature. This type of literature uses a _____ to communicate an absolute truth.

- ▶ The _____ - the bones coming together. In 1897 the first Zionist Congress in Basel, Switzerland resulted in Jewish people coming into the land from 108 nations of the world. This is called _____ which means "go up to Jerusalem". The Jews are responsible to go back to the Temple Mount area in Jerusalem every pilgrim feast day – Passover, Pentecost and Tabernacles.
- ▶ The _____ - the flesh being put on these bones that have come together was the establishment of the Jewish state of Israel on May 15, _____. In Ezekiel 34:11-31 God says He will seek out His sheep and deliver them out of all the places where they have been scattered. God says, "I will" and repeats it _____ times.
- ▶ The _____ - at the end of the Tribulation period, when Jesus Christ returns to the earth, all of Israel will be born again "in a _____." - *Zechariah 3:9*

When were the Jewish people scattered? ____ times.

1. In the first dispersion ____ and his family of 70 people were scattered to _____, and then 430 years later God brings them back into the land.
2. The second dispersion was in ____ BC in Ezekiel's day to _____, and 70 years later God brings them back into the land through Zerubbabel.
3. In ____ AD General Titus and the Roman army devastated the Temple, destroyed the city and dispersed the Jews to the four corners of the earth. Herein lies the third dispersion of the Jewish people in fulfillment of Moses' prophecy to them in Deuteronomy 28. The Arch of ____ still stands in Rome today.

In chapter 36 Ezekiel prophesies a message of _____. God says He will find the Jewish people wherever they are scattered and gather them together in the _____.

When Ezekiel talks about the Land of Israel, it is often associated with the phrase "all the house of Israel."

The land

Currently the Jewish people have only ____% of what God promised to give them. There are 38 locations in Scripture that talk about the Biblical borders of Israel.

The borders start in the South at the _____ River, Egypt, through Lebanon, to the North to the Euphrates River, taking in all of Syria, _____ and Kuwait, 3/4 of Iraq, 3/4 of Saudi Arabia and back to Egypt.

These will be the borders during the _____ Kingdom of Jesus Christ.



The people

- ▶ In _____ the first Zionist Congress was held, and Jews started coming back into the land.
- ▶ Since 1991 1.3 million Russian Jews have come to live in the land, an increase of one nation by ____%. This has never happened in the history of the world.
- ▶ On May 24, 1991 the greatest airlift in history occurred when 42 aircraft transported _____ Ethiopian Jews to Israel. Fourteen babies were born in flight.
- ▶ At the Ben Gurion airport the Israeli government provided a _____ for them. The Ethiopians did not know how to eat it. As Jimmy helped them, he participated in the prophecy of Zephaniah 3:10.

The language

For 2,000 years _____ has been a dead language. It is now restored in Israel in fulfillment of Jeremiah 31:23 and Zephaniah 3:9. God has brought and continues to bring the Jewish people from 108 different nations, dialects and languages back into the land, and they now speak the one language, _____.

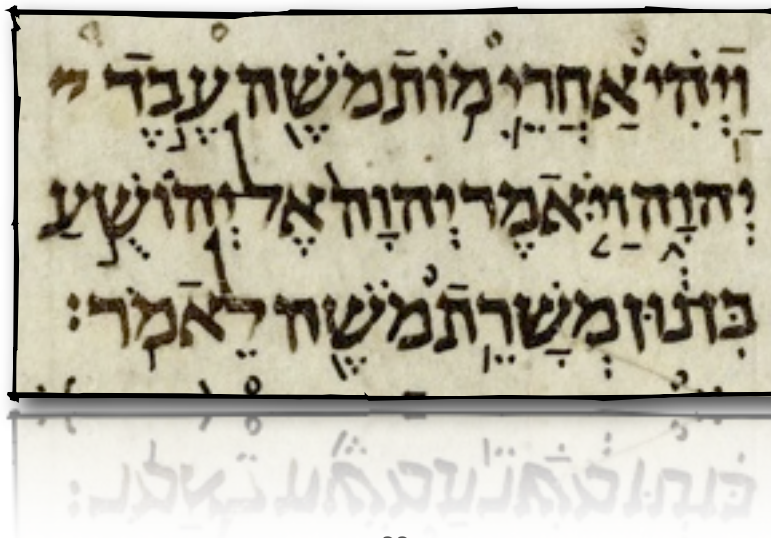

THE CASE FOR ALL TWELVE TRIBES BEING IN THE LAND

The divided kingdom

- ▶ In Ezekiel 37:15 two sticks representing _____ and _____ become one stick.
- ▶ Ezekiel 38 speaks of the alignment of the nations, a coalition of _____ nations that come against the Jewish state.

How can one authenticate the Word of God?

- ▶ Isaiah prophesies 150 years _____ the fact of Cyrus allowing the Jews to go back and rebuild their Temple.
- ▶ Ezra, 150 years _____ that prophecy in Isaiah, records exactly what happened. Almost 50,000 people go back to Jerusalem to build the Temple. Ezra 2:28, 29.

The word Israel is used in one of three ways in the Bible.

- ▶ It is used as the name of _____ when God changed his name to _____ in Genesis 32.
- ▶ It is used to describe all _____ tribes.
- ▶ It is used to describe the _____ tribes that went to the North.
- ▶ It is _____ used to describe the two tribes that stayed in the South.

The priests and Levites come from the tribe of Levi, not those two other southern tribes, Benjamin and Judah. They offered at the dedication of the house of God 100 bullocks, 200 rams and 400 lambs for a sin offering for _____ of Israel. All twelve tribes were in the land.

In Matthew 10:5, 6 the disciples are instructed by Jesus to go to the lost sheep of the house of _____, not to the Gentiles or Samaritans.

Ezekiel uses the word Judah _____ times and Israel 169 times.

All 12 tribes were in the land since the time of Ezra, since the time of Jesus Christ, on the day of _____ and before the _____ of the church.

Then they become two different Jewish states – _____ and _____, and continue as such throughout the seven year Tribulation period.

In Ezekiel 37:22 they again become _____ nation of twelve tribes.

When do the Jewish people become the children of God and God become their God?

- ▶ This occurs when _____ comes back. The Jewish people turn to Christ in a day.

At the Rapture of the Church, Israel becomes two nations,
Israel and Judah.

At the Return of Christ they become one nation again.

What are the current events that relate to this matter?

- ▶ Prime Minister Ehud Olmert promised Israel will evacuate Judea and _____, the West Bank, because the European Union, the United States, the United Nations and Russia say it must be given to the _____. 500,000 Jews live there, 10% of the population of Israel. They went there at the behest of Ariel Sharon after the six day war in 1967.
- ▶ Part of this area is the _____ in Jerusalem, the most sacred piece of real estate to any Jew, and the Garden of Eden.
- ▶ The Israeli government is ready to give this land back, something they did in 2005 when they _____ 10,000 Jews out of 25 Jewish settlements in the Gaza strip.
- ▶ There are those living in Samaria and Judea who say they will not be extracted, their alternative being the establishment of a _____ Jewish state. The constitution for the state of Judah is currently written and ready.
- ▶ _____ the second Jewish state is formed, the Rapture of the Church occurs. That is how close we are. How then should we live?

Conclusion

The prophetic sequence is from Ezekiel 2,500 years ago to...

- ▶ God gathering the Jews into the land,
- ▶ God giving them back their language,
- ▶ The forming of a second Jewish state preceded by the Rapture of the Church.
- ▶ If we are indeed that close, are you prepared for Jesus to come back?

Think About This!

1. What do the events of the valley of the dry bones represent?
2. What are the three Diasporas?
3. How many tribes of Israel will be in the land when Christ returns?
4. What do the two sticks becoming one represent?
5. When will the nation of Judah be formed?

Lesson Five



Islam & the Alignment of the Nations

September 11, 2001 - War was beginning

On 9/11 the Islamic terrorist genie escaped, really, it happened years before at the first attack on the World Trade Center. We are not going to put it back in the bottle. It's the beginning of the end.

Overview of Lesson Five

I. The three main events of the future

II. God's plan for the Jews

III. Satan's plan for the Jews

IV. The alignment of the nations

V. A look at the Islamic world

- *Where did it come from?*
- *Who is the father of Islam?*
- *How does Islam play into end time prophecy?*
- *What will happen to the militant Islamic people?*

Follow Along Outline

The 3 Main Events of the Future

- ▶ The next main event on God's calendar is the _____ of the Church.
- ▶ There will be a seven year _____, the time of Jacob's trouble. - *Jeremiah 30:7*
- ▶ There will be the _____ of Jesus Christ when He establishes His Kingdom.

Reasons for the Tribulation

- ▶ _____ the Jew – Two witnesses will preach and lead 144,000 male virgin Jews to Jesus Christ.
- ▶ _____ the entire world – They in turn will declare the Gospel of the Kingdom throughout the world giving every person opportunity to receive or reject Jesus Christ.

What happens after each of these events?

- ▶ The Millennial _____ - *Ezekiel 40-46*
- ▶ The Great White Throne _____. Jesus as judge will sentence those who rejected Him to the lake of fire, which is the second death. - *Revelation 20:11-15*
- ▶ Eternity _____ - New Heavens, New Earth, and a New Jerusalem



The Borders of God's Promised Land to the Jewish People

- ▶ Half of Egypt, Israel, Lebanon, Syria, Jordan, 3/4 Iraq, Kuwait and 3/4 Saudi Arabia which is ____ times what they currently possess. All this land will be theirs forever, the new earth. Christians will be in the New _____ which will not be on the earth.

During the restoration the Jewish people return to the land in unbelief.

- ▶ ____% of the population of Israel may be religious in the form of Rabbinical Judaism which denies Jesus Christ as the Son of God. According to I John 4 this makes them _____.
- ▶ Ephesians 2 speaks of two people, Jews and Gentiles, being at enmity with each other. Jesus Christ made them one – _____.

What is God's plan for the Jews?

- ▶ He places _____ in the center of the earth. - *Ezekiel 5:5*
- ▶ He brings the ____ into existence.
- ▶ They are to give _____ of the blessings received through obedience.
- ▶ They receive, preserve, and communicate the _____ of God to the world. - *Romans 3*

What is Satan's plan for the Jews?

- ▶ Because of God's plan there is an alignment of nations against _____ motivated by Satan.
- ▶ Satan _____ the human race. The flood was the result. - *Genesis 3:15*
- ▶ The genealogy in Genesis 5 starts with Adam and concludes with Noah. In Genesis 6 God said He found Noah _____ because he did not have any evil angelic strain in his blood line.
- ▶ Noah and his immediate family had the responsibility of _____ the human race.
- ▶ Satan is now going to try to _____ the Jewish people as they come into the land in the Last Days.

Satan's Plots Against the Jews

The Holocaust under Adolf Hitler in World War II

The Spanish Inquisition

Worldwide anti-Semitism

Replacement Theology

If Satan can wipe out the Jew, God's plan fails,
and God is no longer God.

The Alignment of Nations against Israel

- ▶ Persia, Ethiopia, _____, Gomer and Tagarmah of the north quarters. - *Ezekiel 38:5, 6*
- ▶ Magog is a piece of real estate north of the Caspian and Black Seas we know as _____ today.
- ▶ Meshach, Tubal, Gomer and Tagarmah were in Ezekiel's time what we know today as _____.
- ▶ Persia was known in Ezekiel's day what we know today as Afghanistan, Pakistan and _____.
- ▶ Ethiopia then included today's Ethiopia, _____ and Sudan.
- ▶ Daniel 11:40-45 gives us two other nations who will be a part of this coalition, the King of the South (_____) and the King of the North (_____). The he, his and him here is each time referring to Antichrist.

What happens during the short period between the Rapture and the Tribulation?

- ▶ The revived _____ Empire represented by the ten horns of Daniel 7 must come into existence.
- ▶ The _____ must come (the little horn).
- ▶ The Antichrist confirms a _____ agreement with Israel. This is when the clock starts ticking on the seven year Tribulation period.
- ▶ All those dealing with the Antichrist think he is the _____ because he has promised to take care of them.
- ▶ When Egypt and Syria attack Israel, they are attacking the _____.
- ▶ Antichrist is in _____ at the time and returns to wipe out Syria.
- ▶ He skips by Edom, Moab and Ammon (modern-day Jordan). Because of _____, the impregnable city of protection for the Jews during the last 3.5 years of the Tribulation.
- ▶ He goes and destroys _____. - *Daniel 11:42*
- ▶ Tidings out of the east and out of the north shall trouble him. Russia, Iran, Afghanistan and Pakistan. - *Daniel 11:43*
- ▶ The nations listed in Ezekiel 38 are referred in Daniel 11.
- ▶ The first two nations to come against Israel will be Syria and _____.

Is this possible? Let's take a look at the current situation.

SPI WORLD BRIEFING - NEWS FEED

- There are 10,000 Syrian soldiers at the northeastern border of Israel being trained by agents from Hezbollah in guerilla-type warfare.
- The foreign minister of Syria has said the next war with Israel will be ballistic.
- Syria has the Class-C SCUD rocket, the most sophisticated of the scud rockets on alert ready to attack any place in Israel.
- Syria also has biological chemical factories and warheads.
- Syria has said, If Israel does not come to the peace table and give us back the Golan Heights diplomatically, we will take it militarily.
- Egypt in the summer of 2007 held military exercises in the Sinai desert. Why? The Minister of Defense said, We are getting ready for war against the Zionist State, which is Israel.
- Russia has been responsible for giving all the technology and technicians to develop a nuclear weapon of mass destruction to Iran.
- Israeli intelligence says Iran's weapon of mass destruction shall be ready in 2008
- The president of Iran believes we are living in an apocalyptic age.
- Islam has an eschatology that believes a messiah is coming to Jerusalem to head up the one world empire they are going to put in place.
- By the year 2012 Russia will be 50% Islamic, growing faster than anywhere else in the world. By the year 2010 50% of Russia's military will be Islamic
- Turkey is 99% Islamic in their faith. The military is at the point of bringing down the Turkish government.
- Pakistan has the Islamic nuclear weapon and has given it to those who are terrorists.
- Sudan was the headquarters of Osama Bin Laden before moving to where he is today and where the Muslims have killed 2,000,000 Christians.

The writer in Psalm 83:1-4 prays to God that He be not silent to what is going on – the plans of these nations to cut off Israel from being a nation; that the name of Israel may be no more in _____.

- ▶ Edom becomes the _____ of today. - *Psalm 83:6*
- ▶ The Ishmaelites are modern-day _____. - *Psalm 83:6*
- ▶ The Hagarenes are modern-day _____. - *Psalm 83:6*
- ▶ Tyre is modern-day Lebanon. - *Psalm 83:7*
- ▶ Asher is modern-day Syria. - *Psalm 83:8*

On July 9, 2006 in Tehran 4,000 Islamic Arab leaders gathered together. Addressing them the president of Iran said, "We must rise up as Muslims and wipe Israel off the face of the earth that their name may be forgotten forever!" Sounds like Psalm 83:4.

Is Ishmael the father of the Arab world?

- ▶ According to Genesis 16:1 Ishmael did _____ start the Arab world because his mother was one of them. It is impossible for a son to father his mother.
- ▶ Genesis 10:6-10 mentions the sons of Ham, Cush (Ethiopia, Somalia and Sudan), Mizram (_____), Put (Libya) and Nimrod (Babel, modern-day Iraq).
- ▶ Between Genesis 10 and 16 is over _____ years. Ishmael did not father the Arab world.
- ▶ Genesis 17:20 reveals Ishmael would be the father of _____ nation.
- ▶ Genesis 25:18 tells where he went to live – Shur, modern-day _____.

Genesis 25:16 Defined and Explained

- ▶ Nations means _____. Castle means tent. Princes means _____.
- ▶ Ishmael had 12 sons who were chiefs of tribes living in tents. This fits the scene in _____ then and now.
- ▶ The word Arab means Bedouin or _____.
- ▶ Islam means _____. In 622 A.D. Mohammed came to power claiming to be a direct descendant of Ishmael.
- ▶ Mohammed takes Allah as god, which was the moon god. He has no ____, thus making him an _____. Thus Islam was established a Satanic religion that will not exist with any other religion.

When does the Tribulation begin?

- ▶ It begins when Israel dwells in safety in unwallled cities, when Israel lays down her _____, when the Antichrist establishes a _____ peace, when these enemy nations attack. - *Ezekiel 38:8-12*
- ▶ God is against these _____ enemies. 5 out of 6 will be destroyed. - *Ezekiel 39:1, 2*

Conclusion

- ▶ Islam will not collaborate with any other religion.
- ▶ On 9/11 the Islamic terrorist genie escaped, and we are not going to put it back in the box. It is the beginning of the end.
- ▶ Until the rapture occurs they are the force that must be dealt with.

This is the time in which we are living today!

Think About This!

1. What are two of the reasons for the Tribulation Period?
2. What is Satan's plan for the Jewish people?
3. List 5 of the nations that will come against Israel in the End Times.
4. Name one event that comes between the Rapture of the Church and the beginning of the Tribulation period.

Lesson Six



Brother versus Brother - Some Sibling Rivalries never end

The struggle that began in Rebekah's womb long ago continues today with increasing intensity, and it won't end until the Return of Jesus Christ.

Overview of Lesson Six

I. A message of retribution

II. Identifying Mt. Seir

III. Describing the Jacob/Esau struggle

IV. Describing Israel's conflict with Amalek

- *King Saul's disobedience*

- *The Esther story*

- *Obadiah's prophecy*

V. The significance of 70 A.D.

VI. The significance of modern-day events

Follow Along Outline

The Jacob/Esau Conflict: Then & Now

Ezekiel chapter 1-32 contain a message of retribution, chapters 33-48 restoration.

- ▶ Chapter 33 starts the message of restoration.
- ▶ Chapter 34 God is going to bring back the Jewish people to the land.
- ▶ Chapter 36 Ezekiel talks about the land.
- ▶ Chapter 37 he talks about them being restored.
- ▶ Chapters 38 and 39 he talks about the destruction of their enemies.
- ▶ Chapters 40-46 he talks about God's architectural design for the Temple He will build.
- ▶ Chapters 47 and 48 he talks about dividing the land among the twelve tribes of Israel.

However, in chapter 35 it is a message of _____.

- ▶ In verses 1-4 God gives His tough pronouncement of judgment upon _____.
- ▶ In verses 5-15 God gives His reasons.
 - Their perpetual hatred and _____ of the Jews by the force of the sword
 - Their claim to take all the Jewish people, the _____ states of Israel
 - Their speaking against the Jewish people which God considers _____.

Who is Mount Seir? - *Genesis 25:19-23*

- ▶ Abraham and Sarah, barren _____. Then came Ishmael and Isaac.
- ▶ Isaac and Rebekah, barren _____. Then came the first twins in the Bible, Esau and Jacob. Within her womb they were _____ with each other.
- ▶ These twins represent two _____. The one will be stronger than the other, and the elder (_____) shall serve the younger (_____).
- ▶ The first born in a Jewish family gets the _____.
- ▶ Esau _____ his birthright and exchanged it to Jacob for a meal. - *Genesis 25:27-34*.
- ▶ This is the first of _____ privileges for the first born that Esau gives up.

The BIRTHRIGHT

The eldest son has the responsibility of carrying the family onto the next generation.
At the death of their father the father will pronounce a blessing on the eldest son.

What about the blessing?

- ▶ Esau asks his father Isaac to bless him. Isaac's blessing included, "*And by thy sword shalt thou live, and shalt _____ thy brother.*" - *Genesis 27:38-41*
- ▶ Esau _____ Jacob and subsequent to Isaac's death he would kill him.
- ▶ Mother Rebekah sends Jacob to Haran (modern-day _____) to be with Uncle Laban for a while for his safety.
- ▶ While returning home, Jacob has an all night _____ match with Jesus Christ at Peniel east of the Jordan River. - *Genesis 32:24-30*
- ▶ Jesus touched the _____ of Jacob that made him limp the rest of his life. The thigh muscle is ten times stronger than any muscle in one's body.
- ▶ God also changed his name from Jacob to Israel, which means, "I will _____ for you."
- ▶ God was then able to work with Jacob from that point on in his life.
- ▶ Esau's name was changed to _____. - *Genesis 36:1*
- ▶ Edom, when used geographically, is the southern portion of modern-day _____.
- ▶ God allows Jacob to stay in the promised land of _____ (modern-day Israel). - *Genesis 37:1*

Why must Jacob and Esau split?

- ▶ It was because of their _____, their riches and their cattle.
- ▶ Jacob gets the land of _____ (Israel).
- ▶ Esau moves east to dwell in Mount _____. Esau is Edom. - *Genesis 36:8*
- ▶ Mount Seir is the southern third of modern-day _____.
- ▶ Everything between the southern end of the Dead Sea to the Red Sea is Edom on the east side of the Jordan Valley.
- ▶ Esau's headquarters were in a city called Petra.

Petra described

- ▶ It is the most _____ city in the world, recently voted one of the Seven Wonders of the modern world.
- ▶ It is an impregnable city made of _____.
- ▶ It has many colors and is called "The Rose Red City."



Esau & the Amalekites

- ▶ _____ is the grandson of Esau. - *Genesis 36:12*

Israel's Conflict with Amalek

- ▶ Exodus 17 describes the battle between Israel and the _____ at Rephidim. Not all the _____ were destroyed. Some survivors moved into Gibeon near Jerusalem.

God's instructions to King Saul, first king of Israel, regarding Amalek. - *I Samuel 15:3-26*

- ▶ Saul was to kill all their _____ and all the Amalekites.
- ▶ Two days later when asked by Samuel if he did, Saul said he did. The bleating of the _____ in the background revealed his lie.
- ▶ Saul did not kill all the sheep because he thought he could offer them in _____.
- ▶ Saul did not kill King Agag because of his _____ he could use for his cause.
- ▶ Samuel told Saul it is better to _____ than to offer sacrifice. It is better to do what God says than to have to confess sin.
- ▶ Samuel _____ King Agag. - *I Samuel 15:33*

The Queen Esther Story – cast and script

- ▶ King Ahasueras, fourth Persian king richer than the previous three, controlled _____ provinces from India to Ethiopia.
- ▶ _____ was his beautiful wife.
- ▶ The king asks his wife to _____ before all his provincial leaders. She refuses.
- ▶ The king consults with his _____, one of them being Haman.
- ▶ Vashti is dethroned, and the king chooses _____, a Jewess, to be his queen. Her cousin was Mordecai. - *Esther 2*
- ▶ Everybody bowed to Haman, an _____ and number two in the kingdom, except Mordecai. - *Esther 3*

Note the progression:
Esau, Amalek, Agag, Haman –
All four of them wanting to kill Jews.

- ▶ A descendant of Haman is _____ the Great who killed off Jewish boys two years of age and younger declaring he was _____ of the Jews according to the Roman emperor.

The prophecy of Obadiah

- ▶ Judgment is again pronounced against the the Edomites, (the descendants of _____)
- *Obadiah 1-14*
 - Because of _____. "No one can bring us down." - *Obadiah 3*
 - And _____ against his brother Jacob. - *Obadiah 10*
- ▶ At Petra, Esau's headquarters, the _____ would run out to the King's highway and rob the traveling merchants.
- ▶ Obadiah 1-14 is prophecy given _____ years before it was fulfilled.

How God brought down the Edomites

The Edomites invited the Nabateans, the stone carvers of Petra, to a banquet. At this banquet the Nabateans start killing the Edomites. The escaping Edomites go across the Jordan valley to southern Judah and change their name to Edomites.

- ▶ A very famous Edomite was _____ the Great.
- ▶ In 586 B.C. Nebuchadnezzar asked who would like to burn the Temple down. They cast lots, and the lot fell on Esau's descendants, the Edomites. They burned it down, and in so doing sealed their _____ forever.

Obadiah 15 and following is prophecy yet to be fulfilled.

- ▶ The day of the Lord is _____ upon all the heathen.
- ▶ The day of the Lord is any time in history when God _____ in the affairs of men personally on the earth. This is specific use of the phrase.
- ▶ The general use is _____ the Rapture extending through the Tribulation and Millennial Kingdom.
- ▶ The context of Obadiah is the day that Jesus Christ steps back on the _____.
- ▶ The Edomites will be intoxicated with power by controlling the _____ Mount. - *Obadiah 16*
- ▶ The house of Jacob shall be a _____, the house of Joseph a flame and the house of Esau stubble. - *Obadiah 18*
- ▶ At the Return of Christ the _____ people will wipe out the Edomites.

The significance of 70 A.D.

- ▶ Herod the Great, an Edomean, had the _____ refurbished at the time of Christ.
- ▶ In 70 A.D. Roman soldiers
 - ▶ Devastated the _____
 - ▶ Destroyed Jerusalem
 - ▶ _____ the Jews into the four corners of the earth.
- ▶ The Edomites were scattered to a place in the Balkans called _____.

The significance of modern-day events

- ▶ Ahman Al-Hussainy was made the mufti of _____ in the early 1900s.
- ▶ In 1938 Adolf _____ invited him to Berlin, and they made a plan to rid the world of the Jews. Hitler told Ahman El-Hussainy to call for the Islamic world to destroy the Jewish people.
- ▶ First get the elite commando unit from _____, the unit that Hitler would use to (Blitzkrieg) take over a country. They lost.
- ▶ In 1948 the United Nations tells _____ they can become a state among the nations of the world. The Arab world says they will wipe them into the sea.
- ▶ Al-Hussainy had a nephew whose name was _____.
- ▶ Arafat, Al-Hussainy, Herod the Great, Haman, Agag, Amalek, Esau.
- ▶ The descendants of Esau are the _____ people of today who are going to try to kill the Jews and take their land.
- ▶ Obadiah tells when this conflict will be over – at the time of the _____ of Christ. The Palestinians (the Edomites) will be destroyed. Before that will be the seven years of trouble – before that the Rapture.

Conclusion

1. The leaders of the world today are trying to bring a resolution to the Israeli Palestinian conflict (the Jacob/Esau struggle). They will never do it.
2. Only Jesus can do it when He comes back. We are at that point in history.
3. The urgency of the moment requires us to make decisions that will be in accord with God's plan.

Think About This!

1. What country is Mount Seir today?
2. What makes Petra unique?
3. Name 3 famous (or infamous) descendants of Esau.
4. What is the end for the children of Esau?

Lesson Seven



Temples: Past, Present, & Prophetic

Not even evil rulers can get in the way of God's Eternal Plan

The world stage is set for the time of the end, and the alignment of the nations is in place. So believers should get their hearts right, live purely and work productively for the Lord, and unbelievers should make certain they are prepared to meet God.

Overview of Lesson Seven

I. Temples Past

- *The Tabernacle (a prototype) - Exodus 25-28*
- *Solomon's Temple 987 - 587 B.C.*
- *The Second Temple 515 B.C. - 70 A.D.*

II. Temple Present

- *The gold-domed building*

III. Temples Prophetic

- *The Tribulation Temple*
- *Messiah's Temple*

IV. Jesus Christ and the Seven Jewish Feasts

Follow Along Outline

TEMPLES – PAST, PRESENT AND PROPHETIC

The Lord chose Zion for His eternal dwelling place and for His Temple. - *Psalm 132:13, 14*

_____ Temple that Jesus Christ will build is detailed in scripture. - *Ezekiel 40-46*

Temples Past

- ▶ _____ Temple – It was destroyed by Nebuchadnezzar in 587 B.C.
- ▶ The _____ (rebuilt) Temple – It was completed in 515 B.C.

Zechariah was prophesying at the time. From him we learn that it took ___ years for the Jewish people to finish re-building the old temple in 515 B.C. when they should have done it in two or three years. They got more involved in building their own houses instead of God's house.

Jesus Christ tells Zechariah that He is aggressively possessive (_____) for the city of Jerusalem and for Zion. - *Zechariah 1:14*

He is very sorely displeased with those who are _____ secure in controlling the Temple Mount, the location where He is going to come back. - *Zechariah 1:15*

Temple Present

- ▶ The gold-domed building that today stands on the spot where the first and second Temple stood was built in 691 A.D. (over 1,300 years ago). The first Temple stood there for 400 years, and second Temple _____ years.



Temples Prophetic

- ▶ Jesus tells Zechariah He will return to Jerusalem and _____ His Temple. He is speaking of a time yet future. - *Zechariah 1:16*
- ▶ The _____ is one of the names for Jesus Christ. He will be ruler of the entire universe, a Kingdom that will last forever. He will also be the high priest after the order of Melchizedek. - *Zechariah 1:16*

The Tabernacle – the prototype for the coming Temples

- ▶ The _____ of the Covenant - *Exodus 25:10*
- ▶ The _____ of showbread - *Exodus 25:23*
- ▶ The golden _____ (menorah) - *Exodus 25:31*
- ▶ The _____ of fine twined linen blue, purple and scarlet. - *Exodus 26:1*
- ▶ The _____ of the priesthood. - *Exodus 28:2*

The Tabernacle was a portable worship center used for 40 years of wilderness wandering and 350 years at Shiloh in Samaria. The _____ took the Ark of the Covenant for seven months because Israel corrupted themselves. The Philistines were afflicted with hemorrhoids and gave the Ark back. After 120 years King David brings the Ark to Jerusalem. Then King Solomon builds the first Temple.

Solomon's Temple

- ▶ It is built at Jerusalem in Mount _____.
- *II Chronicles 3:1*
- ▶ King David purchased the _____ floor of Ornon the Jebusite which was at the peak of Mount Moriah. It is where God created Adam, where Abraham brought Isaac and offered him, where the Holy of Holies is, where Solomon would build that Temple.
- ▶ From II Chronicles 3 to II Chronicles 36, _____ years pass. Then Nebuchadnezzar of Babylon destroyed that Temple.

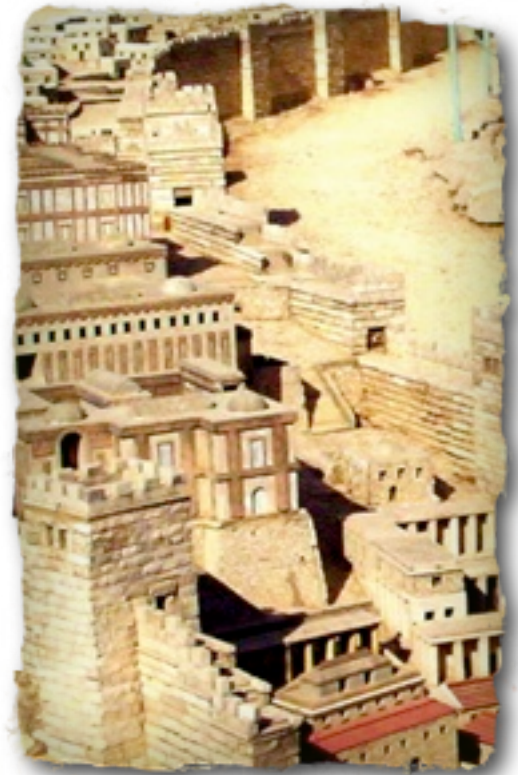

The Second (Rebuilt) Temple

- ▶ God raises up _____ for leadership and Haggai and Zechariah for teaching, preaching and prophesying to the Jews to build the house of God.
- ▶ This second Temple would stand for 600 years until its devastation in ___ A.D. by the Roman army under General Titus.
- ▶ When Titus announced to his troops, "Go for the _____", there was not one stone left upon another in fulfillment of Jesus' prophecy.

What was God's plan in this?

- ▶ All the _____ were destroyed.
- ▶ The sacrificial system would cease. Yom Kippur, the day of atonement, would only cover their sins for one year. Jesus' _____ takes away sin completely.

The Seven Jewish Feasts

The Feasts are for the Jews, not for Christians. But Christians can learn from them.

The Four Spring Feasts - Fulfilled in the first coming of Jesus Christ

- ▶ The Passover – Jesus was _____.

- ▶ The Unleavened Bread which speaks of separation – Jesus was _____.

- ▶ The First Fruits (the barley harvest) – Jesus was _____ - *Leviticus 23 & I Corinthians 15*

- ▶ Pentecost – the coming of the _____ to teach and lift up Jesus Christ.



The Three Fall Feasts - These will be fulfilled in the second coming of Jesus Christ.

- ▶ Rosh Hashanah, the feast of _____, will be fulfilled when Jesus Christ steps back on the earth. - *Matthew 24:31*

- ▶ Yom Kippur (ten days later), the day of _____. Much happens during those 10 days.

- ▶ All the _____ of the world (100 million soldiers) are gathered in Jerusalem. Zechariah 14. This begins the campaign of Armageddon that starts in Jerusalem. Jesus steps down. The Mount of Olives opens up, and that gives a prepared valley for these armies to go 97 miles to Megiddo in the Jezreel Valley to prepare for the final battle.

- ▶ Meanwhile, Jesus is going to _____ the city of Jerusalem (Ezekiel 40:5) that is currently 8.5 square miles. The new Jerusalem will be 50 miles wide and 50 miles long. That is 2,500 square miles. Tel Aviv to the Jordan River is about 76 miles. Ezekiel 45 and Zechariah 14. It is going to be lifted up.

- ▶ Above that is going to be the _____ that will be about a mile square. Currently it is about the size of three football fields. Ezekiel 40-46 tells us the Temple will stand 21 stories (2,100 feet) high. This is Messiah's Temple, the prophetic Temple.

- ▶ Then Jesus goes to the battle field of _____ in the Jezreel Valley. Blood will flow as high as the horse's bridle for 176 miles - the exact distance between Megiddo to the entrance of Petra.

- ▶ Then Jesus gathers the 1/3 of all the Jewish people who are protected at _____ and brings them back to Jerusalem. Two thirds of the Jewish people had been killed. Zechariah 13:8. Where do Jesus and these returning Jews enter the city? It is by way of the Eastern Gate. Ezekiel 43:4. How long will they be there? Forever. Ezekiel 43:7. No more will Israel defile God's Holy Name. Jesus walks into the Holy of Holies on the day of Yom Kippur to become High Priest after the order of Melchizedek.

How does Jesus' high priestly ministry differ from all His earthly predecessors?

- ▶ They were allowed to enter the Holy of Holies once a year with a _____ that would cover their sins and the sins of the people for one year. Jesus Himself was the sacrifice that took away sin once for all. - *Hebrews 9:24-27*
- ▶ Jesus never walked into the Holy of Holies during His first coming. He took His blood into the Holy of Holies in the original Temple in Heaven. - *Hebrews 8*
- ▶ Yom Kippur was the day of atonement for the Jewish people, their _____ salvation.
- ▶ Passover was _____ salvation.

The Feast of Tabernacles – four days after Yom Kippur

- ▶ At the Mount of Transfiguration Peter wanted to erect three tabernacles (Sukkoths – a thatched hut they would live in while traveling in the wilderness). The Feast of _____ would last seven days and is representative of the Kingdom.

How the Fall Feasts relate to the Second Coming of Christ.

- ▶ Rosh Hashanah, the Feast of Trumpets – Jesus _____ to the earth.
- ▶ Yom Kippur, the day of Atonement – Jesus walks into the _____.
- ▶ The Feast of Tabernacles – The _____ _____ begins.

Messiah's Temple

What are the differences between the Tabernacle, the first and second temples and Messiah's Temple?

- ▶ No wall of _____ that separates the Gentiles from the Jews. Jesus made them both one giving all access to the Temple.
- ▶ No table of _____ – Jesus is the bread of life. - *John 6*
- ▶ No _____ (menorah) – Jesus is the light of the world. - *John 8, 9, 11*
- ▶ No _____ – It was rent from top to bottom when Jesus Christ was crucified, giving us access into the Holy of Holies.
- ▶ No _____ of the _____ – It was a model of Christ no longer needed because He is there.

The Tribulation Temple

- ▶ It will be a replica of _____ Temple.
- ▶ There will be restitution of the _____ system in this Temple. - *Ezekiel 45*
- ▶ The seven year Tribulation period begins when the Antichrist confirms a covenant with Israel. In the midst of this time he causes the sacrifices to cease, walks into the Temple and sits down in the Holy of Holies and claims to be god. This is the _____ of _____. Hence, there must be a Temple in this time period. - *Daniel 9:27; Matthew 24:15; II Thessalonians 2:4 and Revelation 11:.*
- ▶ This Temple will stand where that gold-domed building is today and could be built in six months.

Current Preparations for the Next Temple

- ▶ 28,000 _____ are needed to operate the Temple. They have been called to Jerusalem.
- ▶ They need special _____ made out of one piece of cloth. They are in storage.
- ▶ They need 4,000 _____ (the Mizrock, a picture shaped item made of pure gold or pure silver) used to pour out the blood from the sacrifices). They have them.
- ▶ They have the table of _____, the altar of incense, and the menorah.
- ▶ King David called for 4,000 ten stringed _____. They have them, the first ones made in Jerusalem in 2,000 years. The Talmud says that when a ten string harp shows up in Jerusalem, it is time for the coming of the Messiah.
- ▶ In 2005 the Sanhedrin, the group that operates the Temple and elects the high priest, met in Tiberius. A spokesperson for them said, "We have _____ the high priest."
- ▶ Two rabbis have seen the _____ of the _____.

Conclusion

1. Am I like Israel in the days of building the second Temple – more concerned about my agenda than God's agenda for my life? What adjustments must I make? With whom can I share the Gospel?
2. All preparations for the Tribulation Temple have been made ready. Never in the history of the world has everything been ready for this Temple.
3. Only one thing must happen before this Temple goes up, and that is the rapture of the church. Am I ready?
4. If so, how then should I live? I should live like every day is the day of the rapture. Who can I tell about Jesus today? I will make a list of my top five, pray, and then proclaim the good news to them.

Think About This!

1. List the past Jewish Temples.
2. What is the role of the seven Jewish feasts to the Christian?
3. Name two of the feasts that Jesus Christ fulfilled in His first coming.
4. Name two of the feasts that Jesus Christ will fulfill in His second coming.
5. List the two future Temples.

Thank you for studying with us!

We hope this study has been a help to you!

At the School of Prophets Institute, and our parent ministry Shofar Communications, Inc. it is our mission to educate the church about the glorious good news of the soon coming return of Jesus Christ. It is our sincere prayer and desire that the CD series and workbook have been a help to you in your walk with Christ. The knowledge of the immanency of the Rapture should motivate us all to live pure, Christ-centered lives, and lovingly and urgently reach the lost, so our friends, family, neighbors, and coworkers won't have to suffer through the judgments covered in this study.

For further study...

We have a number of other videos, audio series, books, websites, radio broadcasts, and other study materials available to help you on your further studies of God's prophetic Word. Please check out our online bookstore - www.prophecybookstore.com for other materials, and Jimmy DeYoung's website - www.jimmydeyoung.com - for his other prophecy focused ministries.

God bless you, and thanks once again for choosing to study with us the ever closer scenario for the End Times that is laid out in God's prophetic Word. Remember, the Rapture of the Church could take place at any moment, so let's keep looking up... Until.

School of Prophets Institute

PO Box 2510

Chattanooga, TN 37409

(423) 825-6247

www.schoolofprophets.org